

REQUIRED

2-3 Persons 

INCLUDED





Table Top 

Table Legs X2 

Bolts X10 

Washers X10 

Allen Key 



Remove the legs from the box inside the packaging.

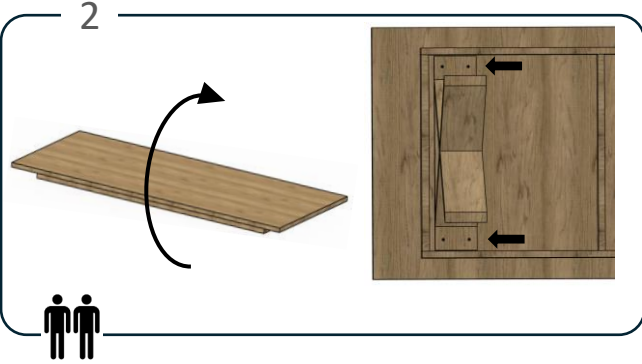

Turn the table top upside down and place legs on both ends of the frame to match the pre-drilled holes in the top and leg supports.

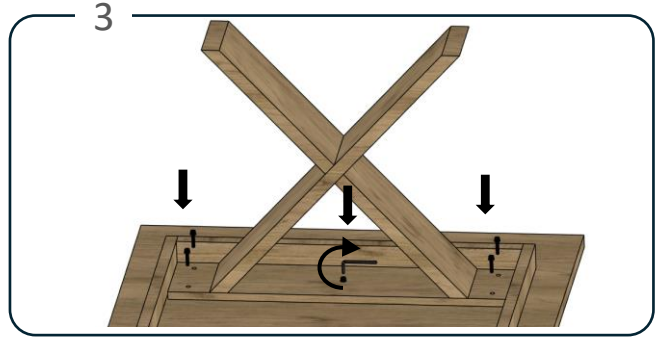

Use the Allen key with to fix the legs to the top by turning the bolts with washers into the pre-drilled holes in the leg supports.

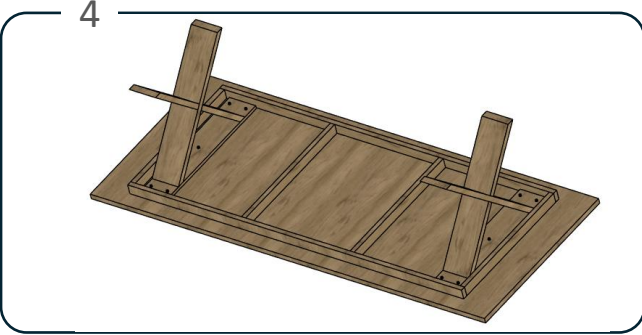

No adjustment needed as legs will fit in place after tightening.

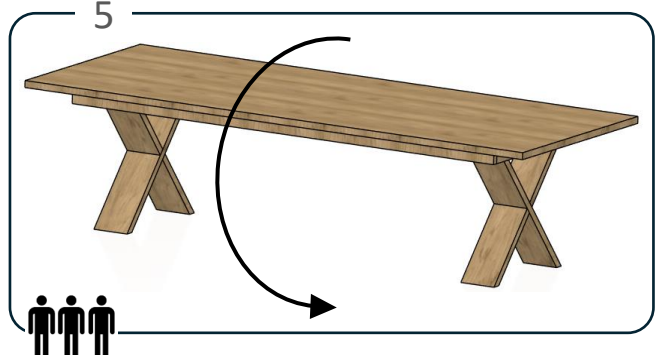

Carefully, turn the table upright and ensure that not to rest the table on its side while doing so.